



Operating Manual

ALTAIR[®] 4 – Four Gas Multigas Detector



Manufactured by
MSA INSTRUMENT DIVISION
P.O. Box 427, Pittsburgh, Pennsylvania 15230, USA



 **WARNING**

Read this manual carefully before using the instrument. The instrument will perform as designed only if it is used and maintained in accordance with the manufacturer's instruction. Otherwise, it could fail to perform as designed and persons who rely on this instrument for their safety could sustain serious personal injury or death.

Contents

1	Instrument Safety	5
1.1	Correct Use	5
1.2	Safety and Precautionary Measures to be Adopted	6
1.3	Warranty.....	9
2	Description	10
2.1	Instrument Overview	10
2.2	Device Hardware Interfaces	11
2.3	Viewing Optional Displays.....	15
2.4	Sensor Missing Alarm	19
2.5	Monitoring Toxic Gases.....	19
2.6	Monitoring the Oxygen Concentration	20
2.7	Monitoring Combustible Gases	21
3	Operation	22
3.1	Environmental Factors	22
3.2	Turning ON the Instrument.....	23
3.3	Measurement Mode (Normal Operation).....	28
3.4	Instrument Setup.....	29
3.5	Data Logging.....	34
3.6	Function Tests on the Instrument.....	35
3.7	Safe LED.....	35
3.8	Bump Test.....	35
3.9	Calibration	37
4	Maintenance	41
4.1	Troubleshooting.....	41
4.2	Live Maintenance Procedure - Replacing and Adding a Sensor ...	42
4.3	Cleaning the Instrument	43
4.4	Storage.....	43
4.5	Shipment.....	43

5	Technical Specifications/Certifications	44
5.1	Technical Specifications.....	44
5.2	Factory-set Alarm thresholds	45
5.3	Certifications	46
5.4	Performance Specification	47
6	Order Information	49
7	Appendix – Flow Charts	50
7.1	Start Up Sequence (Power ON).....	50
7.2	Fresh Air Setup	51
7.3	Reset Screen Controls	52
7.4	Bump Test.....	54
7.5	Options Setup	55
7.6	Sensor Setup	56
7.7	Calibrations	57
7.8	Alarm Setup	58
7.9	Time and Date Setup	59

1 Instrument Safety

1.1 Correct Use

The ALTAIR 4 Multigas Detector is for use by trained and qualified personnel. It is designed to be used when performing a hazard assessment to:

- Assess potential worker exposure to combustible and toxic gases and vapors as well as low level of oxygen.
- Determine the appropriate gas and vapor monitoring needed for a workplace.

The ALTAIR 4 Multigas Detector can be equipped to detect:

- Combustible gases and certain combustible vapors
- Oxygen-deficient or oxygen-rich atmospheres
- Specific toxic gases for which a sensor is installed.

Note: While the instrument can detect up to 25 % oxygen in ambient air, it is approved for use only up to 21 % oxygen.

WARNING

Read and follow all instructions carefully.

- **Perform a bump test before each day's use and adjust if necessary.**
- **Perform a bump test more frequently if exposed to silicone, silicates, lead-containing compounds, hydrogen sulfide, or high contaminant levels.**
- **Recheck calibration if unit is subjected to physical shock.**
- **Use only to detect gases/vapors for which a sensor is installed.**
- **Do not use to detect combustible dusts or mists.**
- **Make sure adequate oxygen is present.**
- **Do not block sensors.**
- **Have a trained and qualified person interpret instrument readings.**
- **Do not recharge Li polymer battery in a combustible atmosphere.**
- **Do not alter or modify instrument.**

INCORRECT USE CAN CAUSE SERIOUS PERSONAL INJURY OR DEATH.

1.2 Safety and Precautionary Measures to be Adopted

WARNING

Carefully review the safety limitations and precautions in this section before placing this instrument in service. Incorrect use can cause serious personal injury or death.

Check function (see section 3.6) each day before use. MSA recommends carrying out a routine inspection prior to each day's use.

Perform a Bump Test (see section 3.8) before each day's use to verify proper instrument operation. The instrument must pass the bump test. If it fails the test, perform a calibration (see section 3.9) before using the instrument.

Perform a bump test more frequently if the unit is subjected to physical shock or high levels of contaminants. Also, perform a bump test more frequently if the tested atmosphere contains the following materials, which may desensitize the combustible gas sensor and reduce its readings:

- Organic silicones
- Silicates
- Lead-containing compounds
- Hydrogen sulfide exposures over 200 ppm or exposures over 50 ppm for one minute.

- The minimum concentration of a combustible gas in air that can ignite is defined as the Lower Explosive Limit (LEL).
A combustible gas reading of "XXX" indicates the atmosphere is above 100 % LEL or 5.00 % vol CH₄, and an explosion hazard exists.
Move away from hazardous area immediately.
- Do not use the ALTAIR 4 Multigas Detector to test for combustible or toxic gases in the following atmospheres as this may result in erroneous readings:
 - Oxygen-deficient or oxygen-rich atmospheres
 - Reducing atmospheres
 - Furnace stacks
 - Inert environments
 - Atmospheres containing combustible airborne mists/dusts.
- Do not use the ALTAIR 4 Multigas Detector to test for combustible gases in atmospheres containing vapors from liquids with a high flash point (above 38 °C, 100°F) as this may result in erroneously low readings.
- Do not block sensor openings as this may cause inaccurate readings. Do not press on the face of the sensors, as this may damage them and cause erroneous readings. Do not use compressed air to clean the sensor holes, as the pressure may damage the sensors.
- Allow sufficient time for unit to display accurate reading. Response times vary based on the type of sensor being utilized (see Section 5.4, "Performance Specifications").
- All instrument readings and information must be interpreted by someone trained and qualified in interpreting instrument readings in relation to the specific environment, industrial practice and exposure limitations.

Risk of explosion: Do not recharge instrument in hazardous area.

Observe proper battery maintenance

Use only battery chargers made available by MSA for use with this instrument; other chargers may damage the battery pack and the unit. Dispose of in accordance with local health and safety regulations.

Use of the GALAXY™ Automated Test System is an alternate approved method for charging ALTAIR 4 instruments.

Be aware of environmental conditions

A number of environmental factors may affect the oxygen sensor readings, including changes in pressure, humidity and temperature.

Pressure and humidity changes affect the amount of oxygen actually present in the atmosphere.

Be aware of the procedures for handling electrostatically sensitive electronics

The instrument contains electrostatically sensitive components. Do not open or repair the unit without using appropriate electrostatic discharge (ESD) protection. The warranty does not cover damage caused by electrostatic discharges.

Be aware of the product regulations

Follow all relevant national regulations applicable in the country of use.

Be aware of the warranty regulations

The warranties made by Mine Safety Appliances Company with respect to the product are voided if the product is not used and maintained in accordance with the instructions in this manual. Please protect yourself and others by following them. We encourage our customers to write or call regarding this equipment prior to use or for any additional information relative to use or service.

1.3 Warranty

ITEM	WARRANTY PERIOD
Chassis and electronics	Two years
All sensors, unless otherwise specified	Two years

1.3.1 Warranty

This warranty does not cover filters, fuses, etc. Certain other accessories not specifically listed here may have different warranty periods. This warranty is valid only if the product is maintained and used in accordance with Seller's instructions and/or recommendations.

The Seller shall be released from all obligations under this warranty in the event repairs or modifications are made by persons other than its own or authorized service personnel or if the warranty claim results from physical abuse or misuse of the product. No agent, employee or representative of the Seller has any authority to bind the Seller to any affirmation, representation or warranty concerning this product. Seller makes no warranty concerning components or accessories not manufactured by the Seller, but will pass on to the Purchaser all warranties of manufacturers of such components.

THIS WARRANTY IS IN LIEU OF ALL OTHER WARRANTIES, EXPRESSED, IMPLIED OR STATUTORY, AND IS STRICTLY LIMITED TO THE TERMS HEREOF. SELLER SPECIFICALLY DISCLAIMS ANY WARRANTY OF MERCHANTABILITY OR OF FITNESS FOR A PARTICULAR PURPOSE.

1.3.2 Exclusive Remedy

It is expressly agreed that Purchaser's sole and exclusive remedy for breach of the above warranty, for any tortious conduct of Seller, or for any other cause of action, shall be the replacement at Seller's option, of any equipment or parts thereof, which after examination by Seller is proven to be defective.

Replacement equipment and/or parts will be provided at no cost to Purchaser, F.O.B. Seller's Plant. Failure of Seller to successfully replace any nonconforming equipment or parts shall not cause the remedy established hereby to fail of its essential purpose.

1.3.3 Exclusion of Consequential Damage

Purchaser specifically understands and agrees that under no circumstances will seller be liable to purchaser for economic, special, incidental or consequential damages or losses of any kind whatsoever, including but not limited to, loss of anticipated profits and any other loss caused by reason of no operation of the goods. This exclusion is applicable to claims for breach of warranty, tortious conduct or any other cause of action against seller.

2 Description

2.1 Instrument Overview

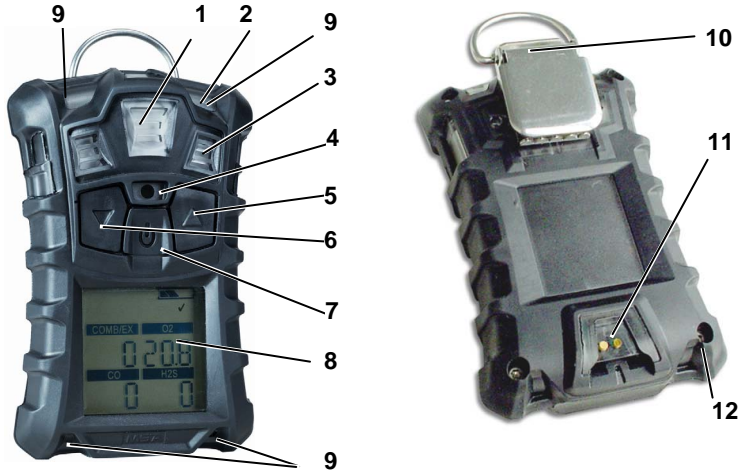

Figure 2-1 Instrument view

- | | | | |
|---|-------------------------------|----|---------------------|
| 1 | MSA Link Communication | 7 | [⏻] Button |
| 2 | Safe LED (green) | 8 | Display |
| 3 | Sensor Inlets | 9 | Alarm LEDs (4) |
| 4 | Horn | 10 | Clip |
| 5 | [▲] Button | 11 | Charging Connection |
| 6 | [▼] Button | 12 | Screws (4) |

The instrument monitors gases in ambient air and in the workplace.

It is available with a maximum of three sensors, which can display readings for four separate gases (one Dual Toxic Sensor provides both CO and H₂S sensing capabilities in a single sensor).

While the instrument can detect up to 25 % oxygen in ambient air, it is approved for use only up to 21 % oxygen.

The alarm levels for the individual gases are factory-set and can be changed through the instrument Setup Menu. These changes can also be made through MSA Link™ software. Ensure that the latest version of the MSA Link™ software has been downloaded from MSA's website www.msanet.com.

If gas is present during Fresh Air Setup, the instrument will fail and enters Measure mode.

2.2 Device Hardware Interfaces

Instrument operation is dialog driven from the display with the aid of the three function buttons (see Figure 2-1).

2.2.1 Button Definitions

Button	Description
[⏻]	The [⏻] button is used to turn instrument ON or OFF and to confirm user action selections. When the [▲] button and the [⏻] button are pressed simultaneously at instrument start-up, the Options Setup Mode displays.
[▼]	The [▼] button is used to move forward through data screens in measuring mode, or as page back and to decrease the values in set-up mode. Holding this button for 3 seconds while in Normal Measure Mode will activate the InstantAlert™ alarm.
[▲]	The [▲] button is used to reset peak, STEL TWA and acknowledge alarms (where possible) or access calibration in measuring mode. It is also used as page up or to increase the values in set-up mode.

2.2.2 LED Definitions

LED	Description
GREEN	The Safe LED flashes once every 15 seconds to notify the user that the instrument is ON and operating under the conditions defined in section 3.7. This option can be turned OFF through the MSA Link software.
RED	The red LEDs are visual indications of an alarm condition or any type of error in the instrument.

2.2.3 Vibrating Alarm

The instrument is equipped with a vibrating alarm.

2.2.4 Backlight

The backlight automatically activates when any button is pressed. The backlight remains ON for the duration of the user-selected timeout. This ON/OFF duration can be set through MSA Link software.

2.2.5 Horn

The horn provides an audible alarm.

2.2.6 On-Screen Indicators

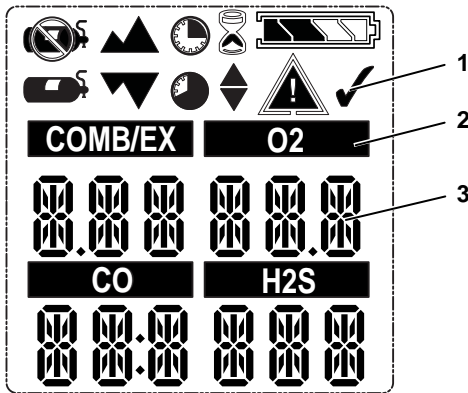

Figure 2-2 Display

- 1 Graphic Symbols
- 2 Gas Type
- 3 Gas Concentration

	Alarm Symbol – Indicates alarm state.		No Gas Cylinder – Indicates cal gas should not be applied and instrument must be exposed to fresh air.
	Bump Check Symbol – Indicates successful bump or cal.		Hourglass – Indicates user should wait.
	Indicates required interaction.		Minimum – Indicates a minimum value or low alarm.
	Battery Condition – Indicates the battery charge level.		PEAK Symbol – Indicates a PEAK reading or high alarm.
	Sensor Labels.		STEL Symbol – Indicates a STEL alarm.
	Motion Alert™ – Indicates Motion Alert™ is active.		TWA Symbol – Indicates a TWA alarm.
	Cal Gas Cylinder – Indicates cal gas must be applied.		

Graphic Symbols

2.2.7 Battery Life Indicator

The battery condition icon continuously displays in the upper right-hand corner of the display. As the battery is depleted, battery icon segments blank until only the battery icon outline remains.

Each indicator segment represents approximately 25% of the total battery capacity.

Battery Warning

WARNING

If battery warning alarm activates while using the instrument, leave the area immediately as the end of battery life is approaching.

Failure to follow this warning can result in serious personal injury or death.

The nominal run-time of the instrument at room temperature is 16 hours. Actual run-time will vary depending on ambient temperature and alarm conditions. The runtime of the instrument at -4 °F (-20 °C) will be approximately 8 hours.

A Low Battery Warning indicates that a nominal 30 minutes of operation remain before the battery's charge is depleted.

The duration of remaining instrument operation during a Low Battery Warning depends on ambient temperatures.

When the instrument goes into Low Battery Warning, the:

- battery life indicator flashes
- alarm sounds
- alarm LEDs flash
- display shows "Low Batt" and 
- instrument repeats this warning every 15 seconds and continues to operate until it is turned OFF or battery shutdown occurs.

Battery Shut Down

WARNING

If battery shutdown alarm activates, stop using the instrument as it no longer has enough power to indicate potential hazards, and persons relying on this product for their safety could sustain serious personal injury or death.

The instrument goes into battery shutdown mode 60 seconds before final shutdown (when the batteries can no longer operate the instrument):

- "Batt Alarm" and  flash on the display
- Alarm sounds and lights flash; alarm cannot be silenced
- No other pages can be viewed; after approximately one minute, the instrument automatically turns OFF.

When battery shutdown condition occurs:

- (1) Leave the area immediately.
- (2) Recharge the battery.

Battery Charging

WARNING

Risk of explosion: Do not recharge instrument in hazardous area.

CAUTION

Use of any charger, other than the Charger supplied with the instrument, may damage or improperly charge the batteries.

- The charger is capable of charging a completely depleted pack in less than four hours in normal, room-temperature environments.
NOTE: Allow very hot or cold instruments to stabilize for one hour at room temperature before attempting to charge.
- Minimum and maximum ambient temperature to charge the instrument is 10°C/50°F and 35°C/95°F, respectively.
- For best results, charge the instrument at room temperature (23°C)

To Charge the Instrument

- Firmly insert the charger connector into the charge port on the back of the instrument.
- The battery symbol  will scroll through a progressively increasing number of segments until 90% of full charge has been obtained. Then it will remain fully illuminated while the battery is trickle charged to its full capacity.
- If a problem is detected during charging, the battery symbol will flash. Disconnect the charger momentarily to reset the charge cycle.

2.2.8 Operating Beep

This operating beep activates every 30 seconds by momentarily beeping the horn and flashing the alarm LEDs under the following conditions:

- Operating beep is enabled
- Instrument is on normal Measure Gases page
- Instrument is not in battery warning
- Instrument is not in gas alarm
- Audible and visual options are enabled

2.3 Viewing Optional Displays

The Main Screen appears at instrument turn-ON.

Optional displays can be viewed by pressing the [▼] button to move to:

2.3.1 Bump Mode

To select the Bump mode, press the [⊕] button.

To move forward, press the [▼] button.

To move backward to the Main page, press the [▲] button.

2.3.2 Peak Readings (PEAK page)

The peak icon  shows the highest levels of gas recorded by the instrument since turn-ON or since peak readings were reset.

To reset the peak readings:

- (1) Access the PEAK page.
- (2) Press the [▲] button.

2.3.3 Minimum Readings (MIN page)

This page shows the lowest level of oxygen recorded by the instrument since turn-ON or since the MIN reading was reset.

The minimum icon ▼ appears on the display.

To reset the MIN reading:

- (1) Access the MIN page.
- (2) Press the [▲] button.

2.3.4 Short Term Exposure Limits (STEL page)

WARNING

If the STEL alarm activates, leave the contaminated area immediately; the ambient gas concentration has reached the preset STEL alarm level. Failure to follow this warning will cause over-exposure to toxic gases and persons relying on this product for their safety could sustain serious personal injury or death.

The STEL icon  appears on the display to show the average exposure over a 15-minute period.

When the amount of gas detected by the instrument is greater than the STEL limit:

- Alarm sounds
- Alarm LEDs flash
- STEL icon flashes.

To reset the STEL:

- (1) Access the STEL page.
- (2) Press the [▲] button.

The STEL alarm is calculated over a 15-minute exposure.

STEL calculation examples:

Assume the instrument has been running for at least 15 minutes:

15-minute exposure of 35 ppm:

$$\frac{(15 \text{ minutes} \times 35 \text{ ppm})}{15 \text{ minutes}} = 35 \text{ ppm}$$

10-minute exposure of 35 ppm and 5 minutes exposure of 15 ppm:

$$\frac{(10 \text{ minutes} \times 35 \text{ ppm}) + (5 \text{ minutes} \times 15 \text{ ppm})}{15 \text{ minutes}} = 25 \text{ ppm}$$

2.3.5 Time Weighted Average (TWA page)

WARNING

If the TWA alarm activates, leave the contaminated area immediately; the ambient gas concentration has reached the preset TWA alarm level. Failure to follow this warning will cause over-exposure to toxic gases and persons relying on this product for their safety could sustain serious personal injury or death.

The TWA icon  appears on the display to show the average exposure since the instrument was turned ON or since the TWA reading was reset. When the amount of gas detected is greater than the eight-hour TWA limit:

- Alarm sounds
- Alarm LEDs flash
- TWA icon flashes.

To reset the TWA:

- (1) Access the TWA page.
- (2) Press the [] button.

The TWA alarm is calculated over an eight-hour exposure.

TWA calculation examples:

1-hour exposure of 50 ppm:

$$\frac{(1 \text{ hour} \times 50 \text{ ppm}) + (7 \text{ hours} \times 0 \text{ ppm})}{8 \text{ hours}} = 6.25 \text{ ppm}$$

4-hour exposure of 50 ppm and 4-hour exposure of 100 ppm:

$$\frac{(4 \text{ hours} \times 50 \text{ ppm}) + (4 \text{ hours} \times 100 \text{ ppm})}{8 \text{ hours}} = 75 \text{ ppm}$$

12-hour exposure of 100 ppm:

$$\frac{(12 \text{ hours} \times 100 \text{ ppm})}{8 \text{ hours}} = 150 \text{ ppm}$$

2.3.6 Time Display

Current time appears on the display in a 12-hour format by default.

A 24-hour format can be selected using MSA Link.

2.3.7 Date Display

Current date appears on the display in the format: **MMM-DD-YYYY**.

2.3.8 Last cal page

Displays the instrument's last successful calibration date in the format: **MMM-DD-YYYY**

2.3.9 Cal due page

Displays the days until the instrument's next calibration is due (user selectable).

2.3.10 Motion Alert Activation (optional)

To activate or deactivate the Motion Alert feature, press the [▲] button while the Motion Alert Activation page is displayed. When the Motion Alert feature is active, the △ symbol will flash every 3 seconds. The instrument will enter pre-alarm when no motion is detected for 20 seconds. This condition can be cleared by moving the instrument.

After 30 seconds of inactivity, the full Motion Alert alarm is triggered. This alarm can only be cleared by pressing the [▲] button.

2.4 Sensor Missing Alarm

The instrument enters the Sensor Missing alarm if the instrument detects that an enabled sensor is not properly installed in the instrument or is not functional.

For O₂, CO, and H₂S sensors, the Sensor Missing feature is checked when the instrument is turned ON and when leaving the Setup mode.

The combustible Sensor Missing feature is continuously monitored.

If a sensor is detected as missing, the following occurs:

- "SENSOR ERROR" displays
- The flag above the sensor detected as missing flashes on the display
- Alarm sounds and lights flash.
- If there is a sensor error at startup, the instrument shuts OFF in 60 seconds.

2.5 Monitoring Toxic Gases

The instrument can monitor the concentration of the following toxic gases in ambient air:

- Carbon Monoxide (CO)
- Hydrogen Sulfide (H₂S)

The instrument displays the gas concentration in parts per million (PPM) or mg/m³ on the Measuring page until another page is selected or the instrument is turned OFF.

WARNING



If an alarm is triggered while using the instrument, leave the area immediately.

Remaining on site under such circumstances can cause serious personal injury or death.

The instrument has four gas alarms:

- HIGH Alarm
- LOW Alarm
- STEL Alarm
- TWA Alarm

If the gas concentration reaches or exceeds the alarm set point, the instrument:

- backlight turns on
- a vibrating alarm triggers
- displays and flashes the Alarm icon  and either the Minimum icon  (LOW alarm) or the Maximum icon  (HIGH alarm)
- enters an alarm state.

2.6 Monitoring the Oxygen Concentration

The instrument monitors the oxygen concentration in ambient air. The alarm set points can be set to activate on two different conditions:

- Enriched - oxygen concentration > 20.8 % or
- Deficient - oxygen concentration < 19.5 %.



While the instrument can detect up to 25% oxygen in the ambient air, it is approved for use only up to 21% oxygen-content.



WARNING

If an alarm activates while using the instrument, leave the area immediately.

Remaining on site under such circumstances can cause serious personal injury or death.

When the alarm set point is reached for either of the above conditions:

- an alarm sounds
- alarm LEDs flash
- a vibrating alarm triggers
- instrument displays and flashes the Alarm icon  and either the Minimum icon  (Enriched alarm) or the Maximum icon  (Deficient alarm) along with the corresponding oxygen concentration.

The LOW alarm (oxygen deficient) is latching and will not automatically reset when the O₂ concentration rises above the LOW set point. To reset the alarm press the [] button. If the alarm condition still exists, the [] button only silences the alarm for five seconds.

False oxygen alarms can occur due to changes in barometric pressure (altitude) or extreme changes in ambient temperature.

It is recommended that an oxygen calibration be performed at the temperature and pressure of use. Be sure that the instrument is in known fresh air before performing a calibration.

2.7 Monitoring Combustible Gases

The instrument can monitor these concentrations in ambient air:

- Methane
- Combustible gases

The instrument displays the gas concentration in % LEL or % CH₄ on the Measuring page until another page is selected or the instrument is turned OFF.

WARNING



If an alarm activates while using the instrument, leave the area immediately.

Remaining on site under such circumstances can cause serious damage to health or can even lead to death.

The instrument has two alarm set points:

- HIGH Alarm
- LOW Alarm

If the gas concentration reaches or exceeds the alarm set point, the instrument:

- backlight turns on
- a vibrating alarm triggers
- displays and flashes the alarm icon  and either the minimum icon  (LOW alarm) or the maximum icon  (HIGH alarm)
- enters an alarm state.

When gas reading exceeds 100% LEL or 5.00% CH₄, the instrument enters a Lock Alarm state and displays "xxx" in place of the actual reading. This state can only be reset by turning the instrument OFF and ON.

WARNING

A combustible gas reading of "100" or "5.00" indicates the atmosphere is above 100 % LEL or 5.00 % vol CH₄, respectively, and an explosion hazard exists. Move away from contaminated area immediately.

In such cases, the instrument LockAlarm feature activates.

3 Operation

Instrument operation is dialog driven from the display with the aid of the three Function buttons (see Section 2).

3.1 Environmental Factors

A number of environmental factors may effect the gas sensor readings, including changes in pressure, humidity and temperature. Pressure and humidity changes affect the amount of oxygen actually present in the atmosphere.

Pressure Changes

If pressure changes rapidly (e.g., stepping through airlock), the oxygen sensor reading may temporarily shift and possibly cause the detector to alarm. While the percentage of oxygen may remain at or near 20.8 vol%, the total amount of oxygen present in the atmosphere available for respiration may become a hazard if the overall pressure is reduced by a significant degree.

Humidity Changes

If humidity changes by any significant degree (e.g., going from a dry, air conditioned environment to outdoor, moisture laden air), oxygen readings can be reduced by up to 0.5 %, due to water vapor in the air displacing oxygen.

The oxygen sensor has a special filter to reduce the effects of humidity changes on oxygen readings. This effect will not be noticed immediately, but slowly impacts oxygen readings over several hours.

Temperature Changes

The oxygen sensor has built-in temperature compensation. However, if temperature shifts dramatically, the oxygen sensor reading may shift. Zero the instrument at a temperature within 86 °F (30 °C) of the work site temperature for the least effect.

3.2 Turning ON the Instrument

Instrument operation is dialog driven from the display with the aid of the three Function buttons (see Section 2.2.1).

For more information, see the flow charts in Section 7.

Turn the instrument ON with the [] button.





The instrument performs a self test and then goes to Fresh Air Setup:

- all display segments are activated
- audible alarm sounds
- alarm LEDs light
- vibrating alarm is activated.

During the self test, the instrument checks for missing sensors.

In the case of a missing sensor, the instrument displays the Sensor Missing screen and alarms until it is turned OFF. Otherwise, the turn-ON sequence continues.

The instrument displays:

- Alarm & display self test
- Manufacturer name
- Instrument name
- Software version
- Combustible gas type
- Toxic gas units
- Alarm set points ( , ) ( , )
- Calibration values
- Date and time display
- Last cal date (if activated)
- CAL due date (if activated)
- Sensor warm-up period
- Fresh Air Setup option.

Refer to flowchart in Appendix, Section 7.1.

3.2.1 Screen Displays during Startup

During the power-up sequence, all automatic page display timeouts are preset to a range from two to four seconds.

Several sequences and screens occur during start up:

Instrument Self Test

The instrument performs a self test.

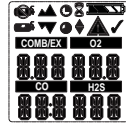

Instrument Name and Software version

Software version and instrument name display.



Combustible Gas Type

Name of Combustible Gas Type displays, e.g. BUTANE.

Combustible gas type can be changed manually through the SENSOR SETUP menu or the MSA Link software.



Toxic Gas Units

Name of Toxic Gas Units displays (ppm or mg/l).

Toxic units can only be modified through the MSA Link software.



Alarm Set points

Alarm set points for all installed and activated sensors display.

LOW alarm set points display, followed by HIGH alarm set points.

Alarm set points can be changed manually through the Setup menu or the MSA Link software.

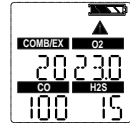
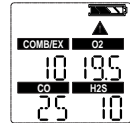

STEL and TWA Set points

The preset STEL and TWA values for installed and activated sensors display.

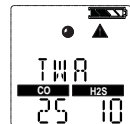

Calibration Values

The preset STEL and TWA values for installed and activated sensors display.

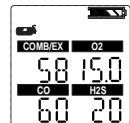

Time and Date

The date displays in a month, day and year format.

In the event that the battery is fully discharged, the time and date reset. At startup, the user is prompted to enter the time and date.

If the time and date information is missing, they are reset to [Jan-01-2008] with time stamp [00:00].



Last CAL Date and CAL Due

These display options can be set by MSA Link software. If these options are not set, these screens are not displayed.

- By default Last Cal is activated.
- By default Cal Due is deactivated.



Sensor Warm Up

The remaining time for sensor Warm Up is shown in a countdown format.



Fresh Air Setup (FAS)

The FAS screen is prompted (see Section 3.2.2)

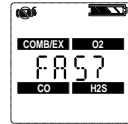

3.2.2 Fresh Air Setup (FAS)

The FAS is for automatic ZERO calibration of the instrument.

The Fresh Air Setup has limits. The zero of any sensor that is outside of these limits will not be adjusted by the FAS command.

If a battery charging cycle is interrupted before it is completed (4 hours for a fully discharged battery), allow the instrument's internal temperature to stabilize for 30 minutes before performing a Fresh Air Setup.

⚠ WARNING

Do not activate the Fresh Air Setup unless you are certain you are in fresh, uncontaminated air; otherwise, inaccurate readings can occur which can falsely indicate that a hazardous atmosphere is safe. If you have any doubts as to the quality of the surrounding air, do not use the Fresh Air Setup feature. Do not use the Fresh Air Setup as a substitute for daily calibration checks. The calibration check is required to verify span accuracy. Failure to follow this warning can result in serious personal injury or death.

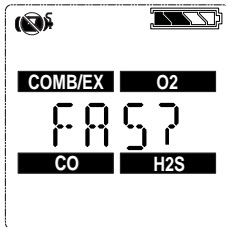

Figure 3-1 Fresh Air Setup







If this option is enabled, the instrument displays "FAS?", prompting the user to perform a Fresh Air Setup (FAS CAL).

- (1) Press the [**▲**] button to bypass the Fresh Air Setup.
 - The Fresh Air Setup is skipped and the instrument goes to the Measuring page (Main page).
- (2) Press the [**⏻**] button within 10 seconds to perform the Fresh Air Setup.
 - The instrument starts the FAS.
 - The screen shows a No Gas Symbol, a blinking hourglass, and all enabled gas sensor readings.
 - At the end of the FAS Calibration, the instrument displays "FAS OK" or "FAS ERR". along with the flags of the sensors that were outside of the FAS limits. All sensors that are within the FAS limits will be zeroed.

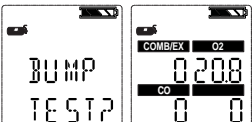
3.3 Measurement Mode (Normal Operation)

In Normal Operation mode, the user can check the Minimum and Peak readings prior to clearing the STEL and TWA values or performing a Span and Zero Calibration.

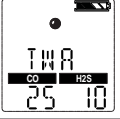
The following options pages can be executed from the Normal Operation screen:

<p>Bump Page This page allows the user to perform a bump check.</p>	
<p>Peak Page This page shows the peak readings for all sensors.</p>	
<p>Min Page This page shows the minimum reading for the oxygen sensor.</p>	
<p>STEL Page This page shows the calculated STEL readings of the instrument.</p>	
<p>TWA Page This page shows the calculated TWA readings of the instrument.</p>	
<p>Time / Date Page This page shows actual time and date settings of the instrument.</p>	
<p>Motion Alert (optional) This page allows the Motion Alert Feature to be activated or deactivated.</p>	

Using the three instrument buttons, the user can navigate through each sub-menu in a top/down sequence.

Refer to section 2.3 and 7.3 in the appendix for detailed instructions on navigating through these screens.

3.4 Instrument Setup

This section describes the configuration options that are available through the Options Setup menus. These menus can be accessed only when the instrument is turned ON while pressing and holding the [▲] button (see Sections 3.2 and 7.3).

This mode can only be activated at instrument turn-ON.

The operation is as follows:

- (1) Press and hold the [▲] button while turning the instrument ON.
 - Use the [▲] and [▼] buttons to enter the setup password. The default password is "672".
- (2) Press [⏏] button to enter the setup menus.
 - Incorrect password: instrument enters the Measure mode.
 - Correct password: instrument continues/beeps three times.

The password can be changed through the MSA Link software.

In the Setup mode:

- Press the [⏏] button to store chosen value or go to the next page.
- Press [▲] button to increase values by one or toggle a selection ON or OFF.
- Press and hold [▲] button to increase values by 10.
- Press [▼] button to decrease values by one or toggle a selection ON or OFF.

Press and hold [▼] button to decrease values by 10.

The following options are available by pressing the [▼] and [▲] buttons:

- Sensor Setup (SENSOR SETUP) - see Section 3.4.1
- Calibration Setup (CAL SETUP) - see Section 3.4.2
- Alarm Setup (ALARM SETUP) - see Section 3.4.3
- Setup Time and Date (TIME SET) - see Section 3.4.4
- EXIT

3.4.1 Sensor Setup

Each sensor can be turned ON or OFF.

For more information, see the flow charts in Section 7.6.

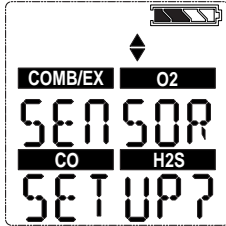

Figure 3-2 Sensor Setup

- (1) To bypass this setup, press the [▼] or [▲] button; otherwise, continue as follows.
- (2) Press the [⏏] button to enter the submenu.
- (3) Use the [▲] or [▼] button to change the option and confirm with the [⏏] button.
- (4) Repeat this procedure for all other sensors.
- (5) After setting the last sensor, continue to Calibration Setup.

3.4.2 Calibration Setup

The user can change and set the calibration values for each sensor.

It is also possible to select whether the Cal Due screen is displayed and set the number of days until the next calibration is due.

For more information, see the flow charts in Section 7.7.

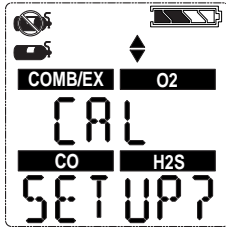

Figure 3-3 Calibration Setup

- (1) To bypass this setup, press the [▼] or [▲] button; otherwise, continue as follows.
- (2) Press the [⏏] button to enter the submenu.
 - The calibration gas concentration of the first sensor is shown.
- (3) Press the [▲] button or the [▼] button to change the value.
- (4) Press the [⏏] button to store the value.
 - Setup screen for the next sensor is displayed.
- (5) Repeat the procedure for all other sensors.
 - After setting the last sensor, the user is prompted to set CALDUE.
- (6) Press the [▲] button or the [▼] button to enable or disable CALDUE. Press the [⏏] button to confirm the selection.
- (7) If CALDUE is set ON, press the [▲] or the [▼] button to select the number of days
- (8) Confirm with the [⏏] button.
- (9) After confirmation, continue to Alarm setup.

3.4.3 Alarm Setup

The user can switch all alarms ON or OFF and change the alarm set points for each sensor.

For more information see the flow charts in Section 7.8.

See section 5.2 for alarm adjustment limits. The value of the High Alarm can only be set to a value that is higher than the Low Alarm set point.

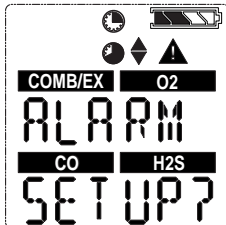

Figure 3-4 Alarm Setup

- (1) To bypass this setup, press the [▼] or [▲] button; otherwise, continue as follows.
- (2) Press the [⏏] button to enter the submenu.
- (3) Set alarms ON or OFF by pressing the [▲] button or the [▼] button. Confirm with the [⏏] button.
 - LOW ALARM settings for the first sensor display
- (4) Press the [▲] button or the [▼] button to change the value.
- (5) Press the [⏏] button to store the value.
 - HIGH ALARM settings for the first sensor display.
- (6) Press the [▲] button or the [▼] button to change the value.
- (7) Press the [⏏] button to store the value.
 - STEL ALARM settings (for toxic sensors only) display.
- (8) Press the [▲] button or the [▼] button to change the value.
- (9) Press the [⏏] button to store the value.
 - TWA ALARM settings (for toxic sensor only) for display.
- (10) Press the [▲] button or the [▼] button to change the value.
- (11) Press the [⏏] button to store the value.
- (12) Repeat the procedure for all other sensors.
- (13) After setting the last sensor, continue to Time and Date setup.

60% L.E.L. or 3.0% volume of methane is the maximum High Alarm set point that can be programmed by the user.

The combustible alarm can be turned OFF by the user in the instrument setup. When the combustible alarm is turned OFF, the only indicator to the user that the combustible alarm is turned OFF occurs during power up of the instrument at which a startup screen will indicate that the combustible alarm is turned OFF. When turned ON, the combustible high alarm is latching. The combustible alarm can be silenced momentarily by pressing the [▲] button. However, if the gas concentration causing the alarm is still present, the unit will go back into alarm.

3.4.4 Setup Time and Date

This submenu is for setting date and time.

For more information see the flow charts in Section 7.9.

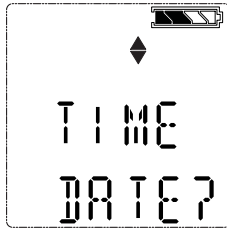

Figure 3-5 Date and Time Setup

- (1) To bypass this setup, press the [▼] or [▲] button; otherwise, continue as follows.
- (2) Press the [⏏] button to enter the submenu.
- (3) Set month by pressing the [▲] button or the [▼] button.
- (4) Press the [⏏] button to confirm month.
- (5) Repeat this procedure for day, year, hours and minutes.
 - By default, time is displayed in 12-hour format.
 - The EXIT screen will be displayed next.
- (6) Confirming this screen with the [⏏] button exits the instrument setup.
 - If the sensors have not warmed up yet, the countdown is displayed.
 - The instrument then goes to Measuring mode.

3.5 Data Logging

Connecting Instrument to PC

- (1) Switch ON the ALTAIR 4 and align the Datalink Communication port on the ALTAIR 4 to the IR interface of the PC.
- (2) Use the MSA Link software to communicate with the instrument. See MSA Link documentation for detailed instructions.

3.6 Function Tests on the Instrument

Alarm Test

Turn ON the instrument. Verify that:

- all LCD segments are activated momentarily
- alarm LEDs flash
- horn sounds briefly
- vibrating alarm triggers briefly.

3.7 Safe LED

The instrument is equipped with a green "SAFE LED". This green SAFE LED flashes every 15 seconds under the following conditions:

- the SAFE LED feature is enabled
- instrument is in Measurement Mode (Normal Operation)
- combustible reading is 0% LEL or 0.00%CH₄
- Oxygen (O₂) reading is 20.8%
- Carbon Monoxide (CO) reading is 0 ppm
- Hydrogen Sulfide (H₂S) reading is 0 ppm or 0 mg/m³
- no gas alarms are present (low or high)
- instrument is not in Low Battery warning or alarm
- CO, H₂S, STEL and TWA readings are 0 ppm or 0 mg/m³.

3.8 Bump Test

WARNING

Perform a Bump Test before each day's use to verify proper instrument operation. Failure to perform this test can result in serious personal injury or death.

This test quickly confirms that the gas sensors are functioning. Perform a full calibration periodically to ensure accuracy and immediately if the instrument fails the Bump Test. The Bump Test can be performed using the procedure below or automatically using the Galaxy Test Stand.

CSA requires (per 22.2 NO. 152) that the instrument's sensitivity be tested before each day's use on a known concentration of methane equivalent to 25-50% of full scale concentration. ACCURACY MUST BE WITHIN 0 to +20% OF ACTUAL. Correct accuracy by performing the calibration procedure within this manual.

3.8.1 Equipment.

See accessory section for ordering information for these components.

- Calibration Check Gas Cylinder
- 0.25 liters/min. Flow Regulator
- 1/8" ID Superthane Ester Tubing
- Altair 4 Calibration Cap

3.8.2 Performing a Bump Test

To skip the Bump Test procedure, push the [▲] button repeatedly to return to Measuring mode. If no button is pushed for 30 seconds, the instrument returns to the Measuring mode automatically.

- (1) From the normal measure screen press the [▼] button to display "BUMP TEST?".
- (2) Verify the gas concentrations displayed match the Calibration Check Gas Cylinder. If they do not, adjust the values through the Calibration Setup menu as described in section 3.4.2.
- (3) Attach the calibration cap to the instrument.
 - Insert tab on calibration cap into slot on instrument.
 - Press calibration cap as shown until it seats onto instrument.

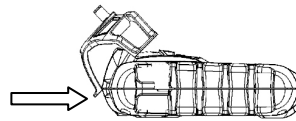
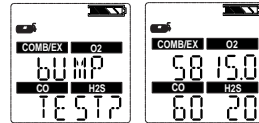

- Press both side tabs down onto instrument until they snap in.
- Ensure that the calibration cap is properly seated.
- Connect one end of the tubing to the calibration cap.
- Connect other end of tubing to the cylinder regulator (supplied in the calibration kit).

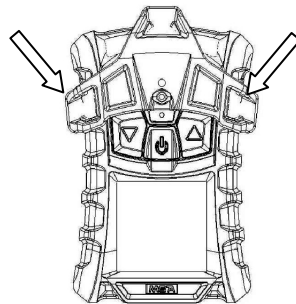

- (5) Press the [ϕ] button to start the bump test then open the valve on the regulator. The hourglass will flash and the sensors will respond to the gas.

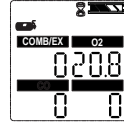

After the Bump Test completes, the instrument momentarily displays “BUMP PASS” or “BUMP ERROR” along with the label of any sensor that failed before returning to Measure mode. If the instrument fails the Bump Test, perform a calibration as described in section 3.9.



The √ symbol will be displayed in the Measure mode for 24 hours after a successful Bump Test.

3.9 Calibration

The ALTAIR4 can be calibrated either manually using this procedure or automatically using the Galaxy Test Stand. Refer to 7.7 of the appendix.

Calibration must be performed using a flow regulator with a flow rate set to 0.25 liters per minute.

If a battery charging cycle is interrupted before it is completed (4 hours for a fully discharged battery), allow the instrument's internal temperature to stabilize for 30 minutes before performing a Calibration.

3.9.1 Zero Calibration

To skip the ZERO procedure and move directly to the calibration span procedure, push the [▲] button. If no button is pushed for 30 seconds, the instrument prompts user to perform a SPAN calibration before returning to the Normal Operation mode.

- (1) Press and hold the [▲] button in Normal Operation mode for three seconds
- (2) If calibration lockout option is selected, enter password.

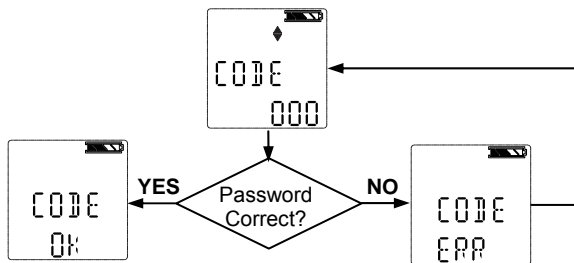

- ZERO screen is then displayed.

If calibration lockout option is **NOT** selected:

- ZERO screen displays.

- (3) With the instrument exposed to fresh air, press the [⏏] button to confirm the ZERO screen.

- The hourglass will flash during the 10 second sensor zero adjustment.

After ZERO calibration completes, the instrument momentarily displays “ZERO PASS” or “ZERO ERR” along with the flag of any sensor that failed.

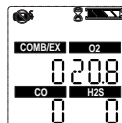
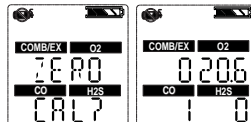

3.9.2 Span Calibration

To skip the Span procedure, push the [▲] button.

If no button is pushed for 30 seconds, the instrument returns to the Measuring mode.

- (1) Once the zero is set, the span screen displays.
- (2) Connect the appropriate calibration gas to the instrument.
- (3) Attach the calibration cap to the instrument.

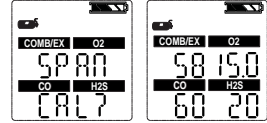

- Insert tab on calibration cap into slot on instrument.
- Press calibration cap as shown until it seats onto instrument.

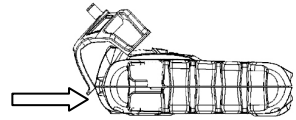

- Press both side tabs down onto instrument until they snap into.
- Ensure that the calibration cap is properly seated.
- Connect one end of the tubing to the calibration cap.
- Connect other end of tubing to the cylinder regulator (supplied in the calibration kit).

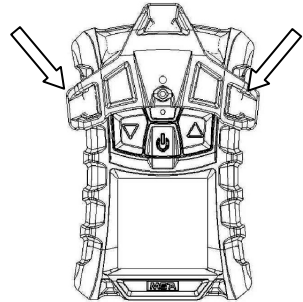

- (4) Open the valve on the regulator.
- (5) Press the [⊕] button to calibrate (span) the instrument.
 - LEDs flash
 - SPAN calibration starts.

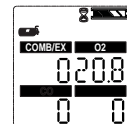

After the SPAN calibration completes, the instrument momentarily displays “SPAN PASS” or “SPAN ERR” along with the label of any sensor that failed then returns to the Measuring mode.

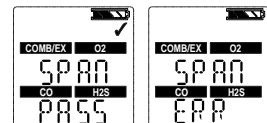

3.9.3 Finishing Calibration

- (1) Close the valve on the regulator.
- (2) Remove the calibration cap.

The calibration procedure adjusts the span value for any sensor that passes the calibration test; sensors that fail calibration are left unchanged. Since residual gas may be present, the instrument may briefly go into an exposure alarm after the calibration sequence is completed.

3.9.4 Autocalibration Failure

If the instrument cannot calibrate one or more sensor(s), it goes to the SPAN ERR page and remains in alarm until the user presses the [▲] button.

Sensors that could not be calibrated are indicated by flashing sensor icons.

If the combustible sensor fails calibration after the full calibration procedure in this manual has been performed, replace the combustible sensor.

4 Maintenance



If an error occurs during operation, use the displayed error codes to determine appropriate next steps.

WARNING

Repair or alteration of the Altair 4 Multigas Detector, beyond the procedures described in this manual or by anyone other than a person authorized by MSA, could cause the instrument to fail to perform properly. Use only genuine MSA replacement parts when performing any maintenance procedures described in this manual. Substitution of components can seriously impair instrument performance, alter intrinsic safety characteristics or void agency approvals.

FAILURE TO FOLLOW THIS WARNING CAN RESULT IN SERIOUS PERSONAL INJURY OR DEATH.

4.1 Troubleshooting

Problem	Description	Reaction
ERROR TEMP	Temperature is below -40°C or above 75°C.	Return instrument to normal temperature range and recalibrate. Contact MSA
ERR/AD COMB ERR/AD MAIN	Sensor measurement error	Contact MSA
ERROR CMBPWR	Combustible sensor power supply error.	Contact MSA
ERROR EE	EEPROM Memory error	Contact MSA
ERROR PRG	Flash Memory error	Contact MSA
ERROR RAM	RAM Memory error	Contact MSA
ERROR UNK	Unknown error	Contact MSA
 LOW BATT	Battery warning repeats every 15 seconds.	Remove from service as soon as possible and recharge battery
 BATT ALARM	Battery is completely discharged.	Instrument is no longer sensing gas. Remove from service and recharge battery.
ERROR SENSOR	Sensor error	Replace sensor and recalibrate. Contact MSA
Instrument does not turn ON	Low battery	Charge instrument

4.2 Live Maintenance Procedure - Replacing and Adding a Sensor

NOTICE

Before handling the PC board, the user must be properly grounded; otherwise, static charges could damage the electronics. Such damage is not covered by the warranty. Grounding straps and kits are available from electronics suppliers.

WARNING

Remove and reinstall sensors carefully, ensuring that the components are not damaged; otherwise instrument intrinsic safety may be adversely affected, wrong readings could occur, and persons relying on this product for their safety could sustain serious personal injury or death.

To add a sensor to an instrument that is not already equipped with a full array of sensors, remove the sensor plug from in front of the formerly unused sensor housing.

NOTICE

While instrument case is open, do not touch any internal components with metallic/conductive objects or tools. Damage to the instrument can occur.

- (1) Verify that the instrument is turned OFF.
- (2) Remove the four case screws, and remove the case front while carefully noting the orientation of the sensor gasket.
- (3) Gently lift out and properly discard the sensor to be replaced.
 - Using fingers only, gently remove the toxic, combustible, or oxygen sensor by gently rocking it while pulling it straight from its socket.
- (4) Carefully align the new sensor contact pins with the sockets on the printed circuit board and pressing it firmly in place.
 - Insert the toxic sensor by placing it in the left-hand position of the sensor holder.
 - Insert the O₂ sensor by placing it in the middle position of the sensor holder.
 - Insert the combustible sensor by placing it in the right-hand position of the sensor holder.

Ensure groove in combustible sensor aligns with tab at top of holder.

- If any sensor is not to be installed, ensure that a sensor plug is installed properly in its place.
- (5) If replacing sensor filters at this time:
- Carefully peel off old filters taking care not to damage the inside of the case.
 - On new filters peel off backing exposing adhesive. Note proper orientation of each filter and apply to inside of front case adhesive side against case.
 - Press filter into place taking care not to damage filter surface.
- (6) Reinstall the sensor gasket in the case front.

Ensure sensor gasket is properly installed.

- (7) Re-install the screws.
- (8) If this sensor channel was deactivated, go into the sensor setup and turn ON the sensor.
- (9) Calibrate the instrument after the sensors have stabilized.

Allow sensors to stabilize at least 30 minutes before calibration.

 **WARNING**

Calibration is required after a sensor is installed; otherwise, the instrument will not perform as expected and persons relying on this product for their safety could sustain serious personal injury or death.

4.3 Cleaning the Instrument

Clean the exterior of the instrument regularly using only a damp cloth. Do not use cleaning agents.

4.4 Storage

When not in use, store the instrument in a safe, dry place between 65°F and 86°F (18 °C and 30 °C). After storage, always recheck instrument calibration before use.

4.5 Shipment

Pack the instrument in its original shipping container with suitable padding. If the original container is unavailable, an equivalent container may be substituted.

5 Technical Specifications/Certifications

5.1 Technical Specifications

Weight	0.300 lb (instrument with battery and clip)			
Dimensions (L x W x H)	4.4 x 3.00 x 1.37 inches – without fastening clip			
Alarms	Four LEDs, an audible alarm and a vibrating alarm			
Volume of audible alarm	95 dB typical			
Display	LCD display			
Battery type	Rechargeable Li polymer battery. Li polymer battery must not be charged in Ex area.			
Instrument run time	16 hours at 77°F (25 °C)			
Charging time	≤ 4 hours The maximum safe area charging voltage Um = 6.7 Volts D.C.			
Temperature range	-4 °F to 122 °F (-20 °C to 50 °C) operating 50 °F to 95 °F (10 °C to 35 °C) while charging battery			
Humidity range	15 % – 90 % relative humidity, non-condensing, 5 % – 95 % RH intermittent			
Atmospheric pressure range	11.6 to 17.4 PSIA (800 kPA to 1200 kPA)			
Ingress protection	IP 67			
Measuring methods	Combustible gases:	Catalytic sensor		
	Oxygen:	Electrochemical sensor		
	Toxic gases	Electrochemical sensor		
Warranty	Standard two years. Extended options available. See full warranty for specific limitations.			
Measuring range	Combustible	O₂	CO	H₂S
	0-100% LEL 0-5.00% CH ₄	0-25 % Vol.	0-999 ppm	0-200 ppm

5.2 Factory-set Alarm thresholds

Sensor	LOW alarm	HIGH alarm	STEL	TWA
LEL	10 % LEL	20 % LEL	--	--
O ₂	19.5 %	23.0 %	--	--
CO	25 ppm	100 ppm	100	25
H ₂ S	10 ppm	15 ppm	15	10

Sensor	Min. alarm set point	Max. alarm set point	Auto-cal values
LEL	5	60	58%
O ₂	5.0	24	15.0%
CO	20	950	60 ppm
H ₂ S	5	175	20 ppm

This instrument is not approved for use in atmospheres containing >21 % oxygen.

5.3 Certifications

See instrument label for the approvals that apply to your specific unit.

USA and Canada

USA



Exia

Class I, Groups A, B, C, D, F, G
 Ambient temperature: -4°F to +122°F; T4

Canada



Exia

Class I, Groups A, B, C, D
 Ambient temperature: -4°F to +122°F; T4

ONLY THE COMBUSTIBLE DETECTION PORTION OF THIS INSTRUMENT HAS BEEN ASSESSED FOR PERFORMANCE BY THE CANADIAN STANDARDS ASSOCIATION (C.S.A.).

Other Countries

Australia

Ex ia IIC T4
 Ambient temperature: 122°F

European Community

The product ALTAIR 4 complies with the following directives, standards or standardized documents:

Directive 94/9/EC (ATEX) : FTZU 06 ATEX 0134 X
 II 2G EEx ia IIC T4
 -20 °C ≤ Ta ≤ +50 °C
 EN 50 014, EN 50 020

Directive 2004/108/EEC (EMC) : EN 50 270 Type 2, EN 61 000-6-3



5.4 Performance Specification

5.4.1 Combustible Gas

Range	0 to 100 % LEL or 0 to 5 % CH ₄
Resolution	1 % LEL or 0.05 % vol CH ₄
Reproducibility	3 % LEL, 0 % to 50 % LEL reading or 0.15 % CH ₄ , 0.00 % to 2.50 % CH ₄ (normal temperature range)
	5 % LEL, 50 % to 100 % LEL reading or 0.25 % CH ₄ , 2.50 % to 5.00 % CH ₄ (normal temperature range)
	5 % LEL, 0 % to 50 % LEL reading or 0.25 % CH ₄ , 0.00 % to 2.50 % CH ₄ (extended temperature range)
	8 % LEL, 50 % to 100 % LEL reading or 0.40 % CH ₄ , 2.50 % to 5.00 % CH ₄ (extended temperature range)
Response time	90 % of final reading in less than or equal to 30 sec (normal temperature range)

5.4.2 Oxygen

The oxygen sensor has built-in temperature compensation. However, if temperature shifts dramatically, the oxygen sensor reading may shift. Zero the instrument at a temperature within 86°F (30 °C) of the work place temperature for the least effect.

Range	0 to 25 vol.% O ₂
Resolution	0.1 vol.% O ₂
Reproducibility	0.7 vol.% O ₂ for 0 to 25 vol.% O ₂
Response time	30 second (normal temperature range) 3 minutes (extended temperature range)

5.4.3 Carbon Monoxide

Range	0 - 999 ppm CO
Resolution	1 ppm CO, for 0 to 500 ppm CO
Reproducibility	± 5 ppm CO or 10 % of reading, whichever is greater (normal temperature range) 0 to 300 ppm CO,
	± 15 % >300 ppm CO (normal temperature range)
	± 10 ppm CO or 20 % of reading, whichever is greater (extended temperature range)
Response time	90% of final reading in less than or equal to 30 seconds (normal operation range) 60 seconds (normal temperature range)

5.4.4 Hydrogen Sulfide

Range	0 - 200 ppm H ₂ S
Resolution	1 ppm H ₂ S, for 3 to 200 ppm H ₂ S
Reproducibility	± 2 ppm H ₂ S or 10 % of reading, whichever is greater (normal temperature range) 0 to 100 ppm H ₂ S,
	± 15 % >100 ppm H ₂ S (normal temperature range)
	± 5 ppm H ₂ S or 10 % of reading, whichever is greater (extended temperature range)
Response time	90% of final reading in less than or equal to 30 seconds (normal operation range) 60 seconds (normal temperature range)

6 Order Information

Description	Part No.
SS Suspender Clip	10069894
Belt clip	10089322
34L quad gas mix (1.45% CH ₄ , 15% O ₂ , 60 ppm CO, 20 ppm H ₂ S)	10048280
58L quad gas mix (1.45% CH ₄ , 15% O ₂ , 60 ppm CO, 20 ppm H ₂ S)	10045035
Universal pump probe (UL)	10046528
Universal pump probe (CSA)	10055576
Universal pump probe (AUS)	10047594
Universal pump probe (ATEX)	10047596
Calibration assembly (cap, tube, connector)	10089321
Charging cradle assembly	10086639
North American Power Supply	10047342
Australian Power Supply	10058037
European Power Supply	10065716
Australian Power Supply with IEC barrier	10089487
European Power Supply with IEC barrier	10089488
MSA Link Software CD- Rom	10088099
JetEye IR adapter with USB connector	10082834
Combustible sensor	10089116
O ₂ sensor	10046946
CO/H ₂ S duo-tox sensor	10089117
Sensor replacement kit (duo-tox, O ₂ , combustible)	10089118
Front Housing with integrated dust filters	10089162
Main board w/ battery pack	10089161
LCD frame assembly (frame, LCD, zebra strips, screws)	10089120
Spare filters, sensors gasket, socket head cap screws (4x), self tapping (2x)	10089119
CD Manual ALTAIR 4	10088159

7 Appendix – Flow Charts

7.1 Start Up Sequence (Power ON)

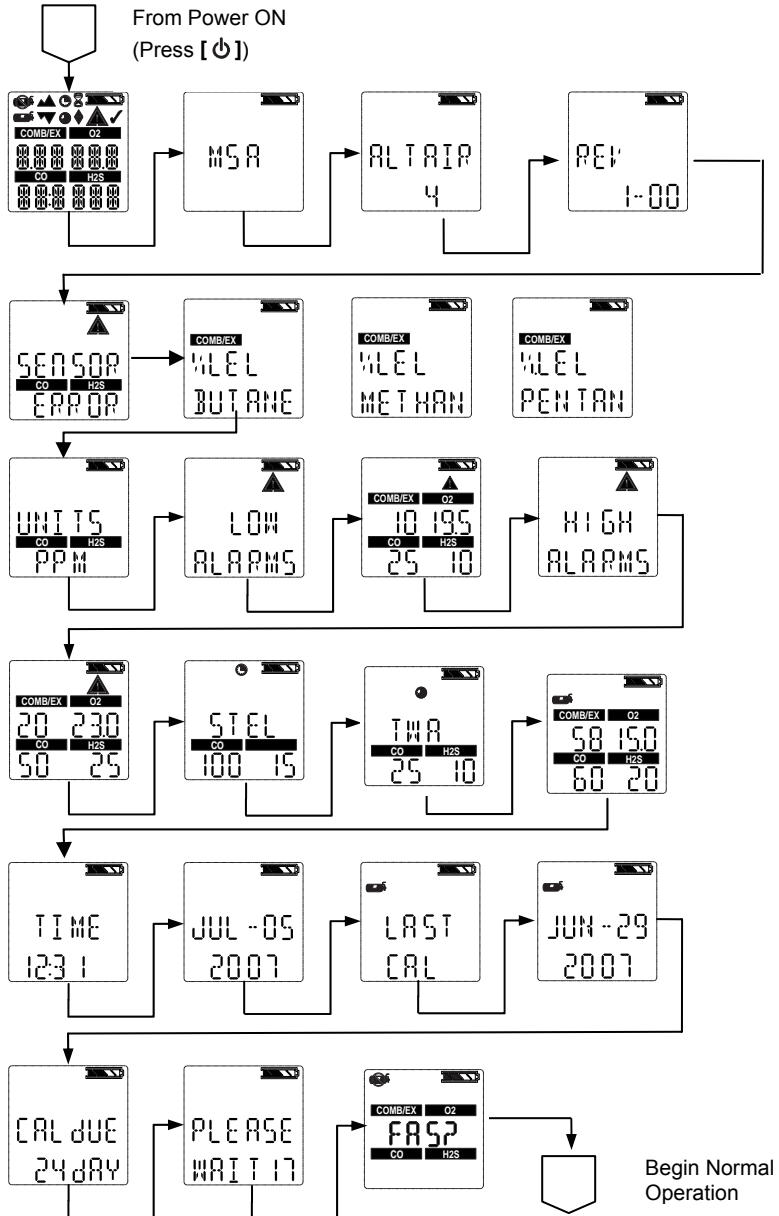

7.2 Fresh Air Setup

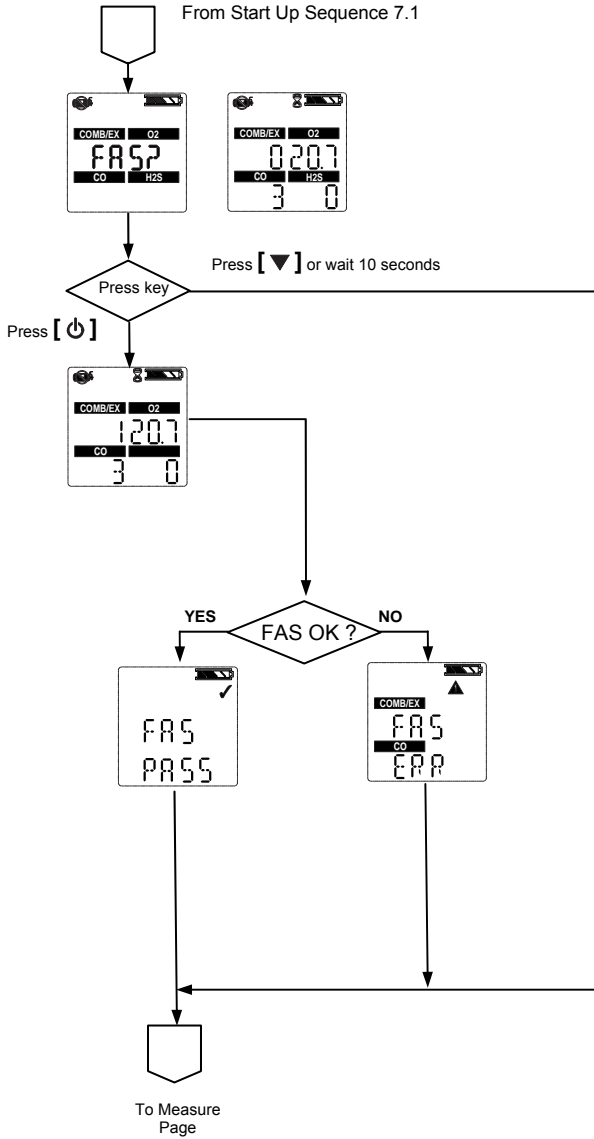

7.3 Reset Screen Controls

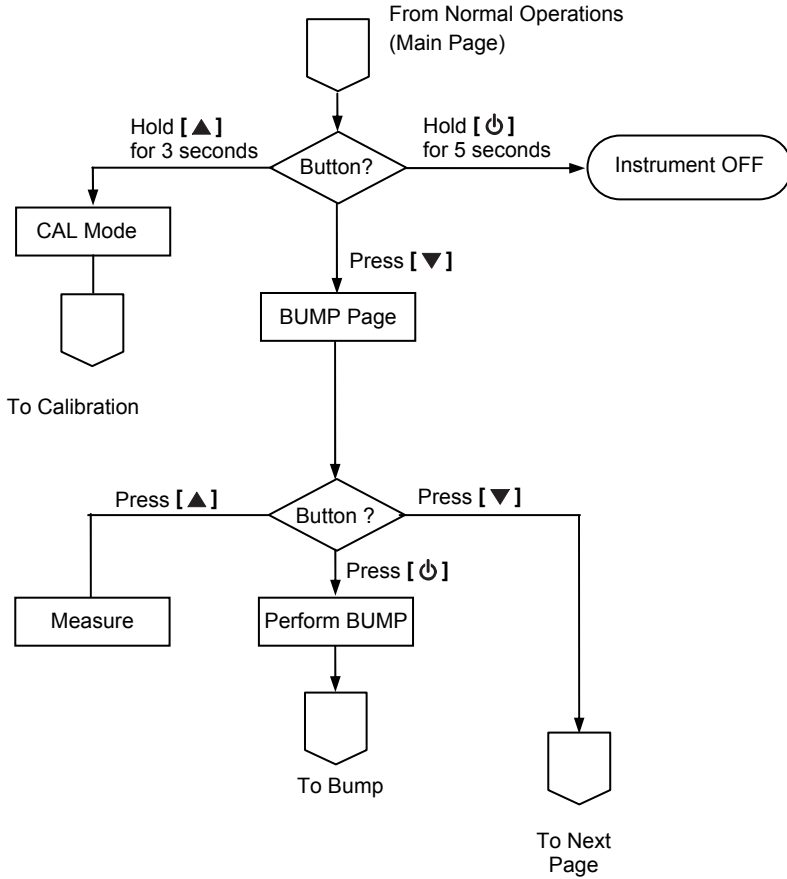

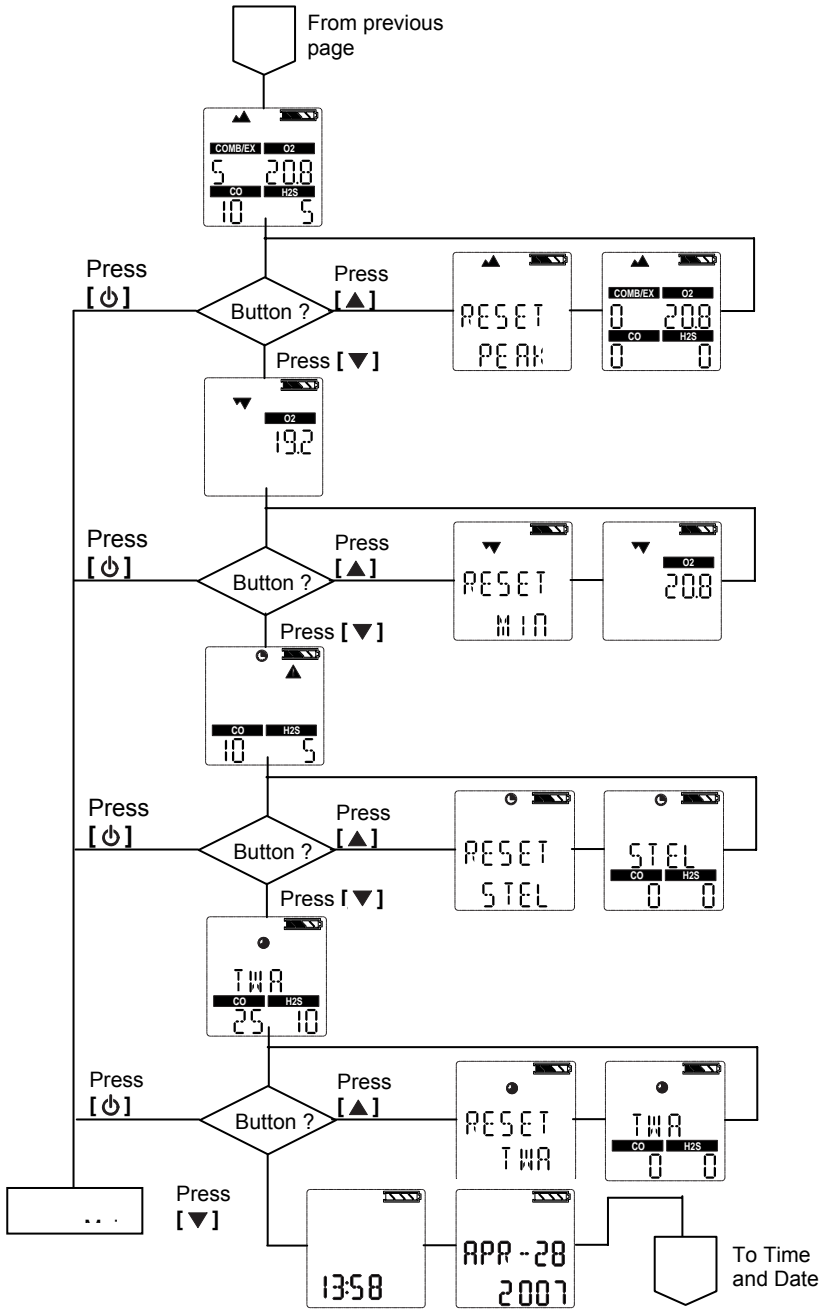

7.4 Bump Test

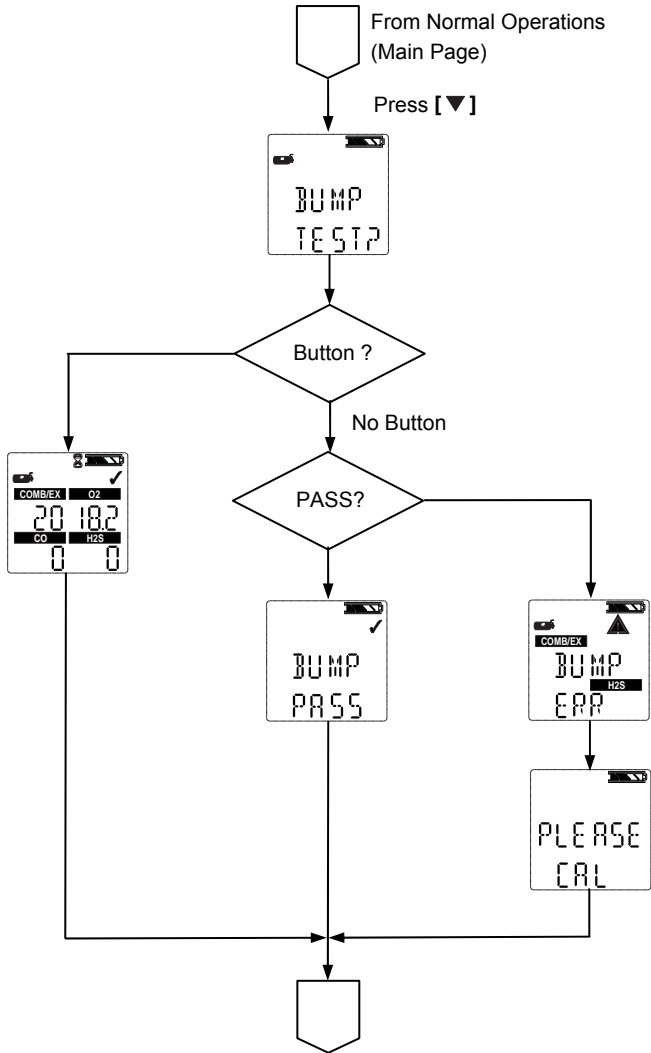

7.5 Options Setup

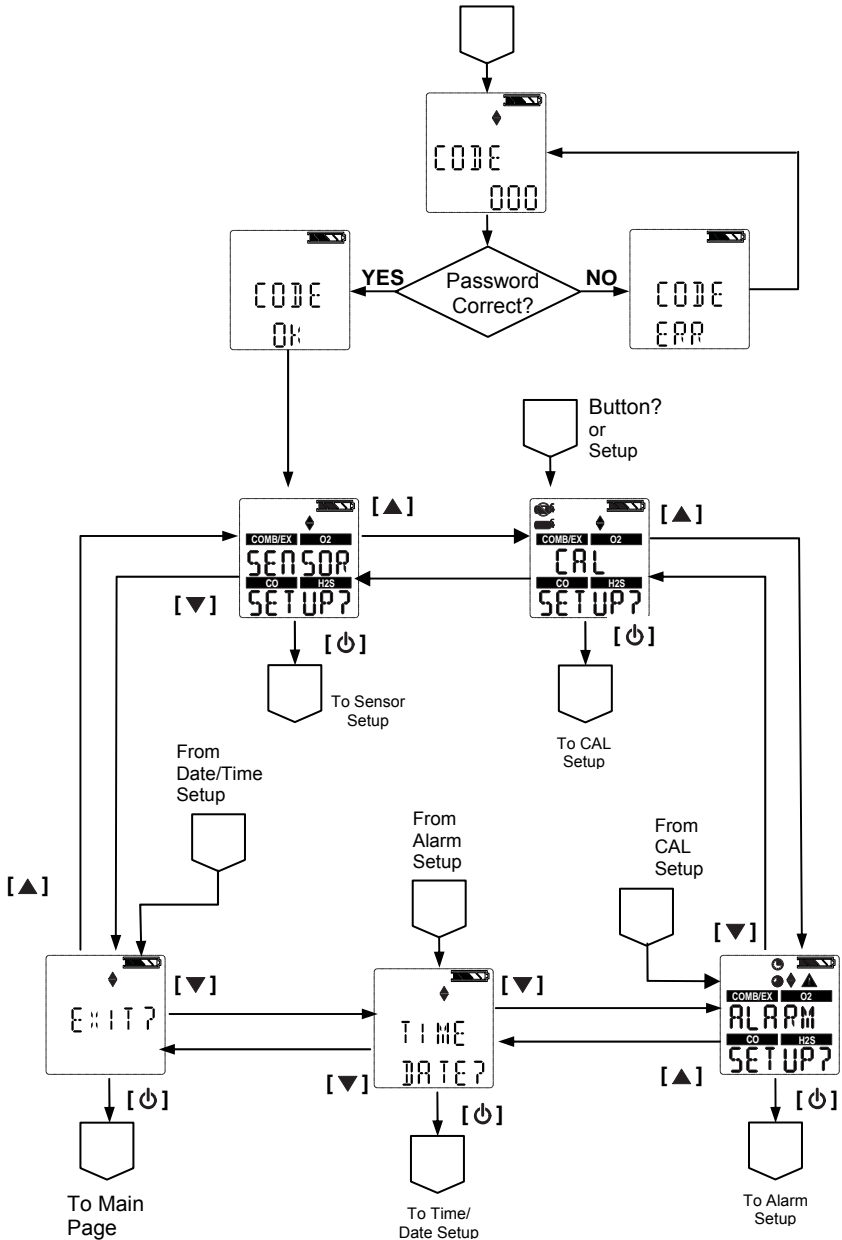

7.6 Sensor Setup

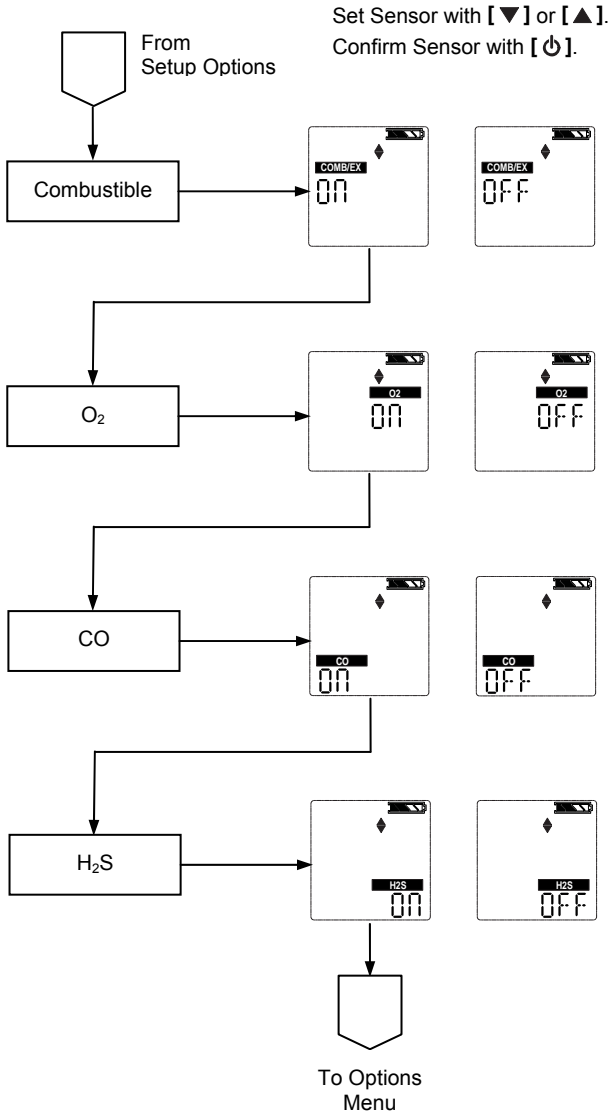

7.7 Calibrations

From Measure Page when [▲] is held for 3 seconds.

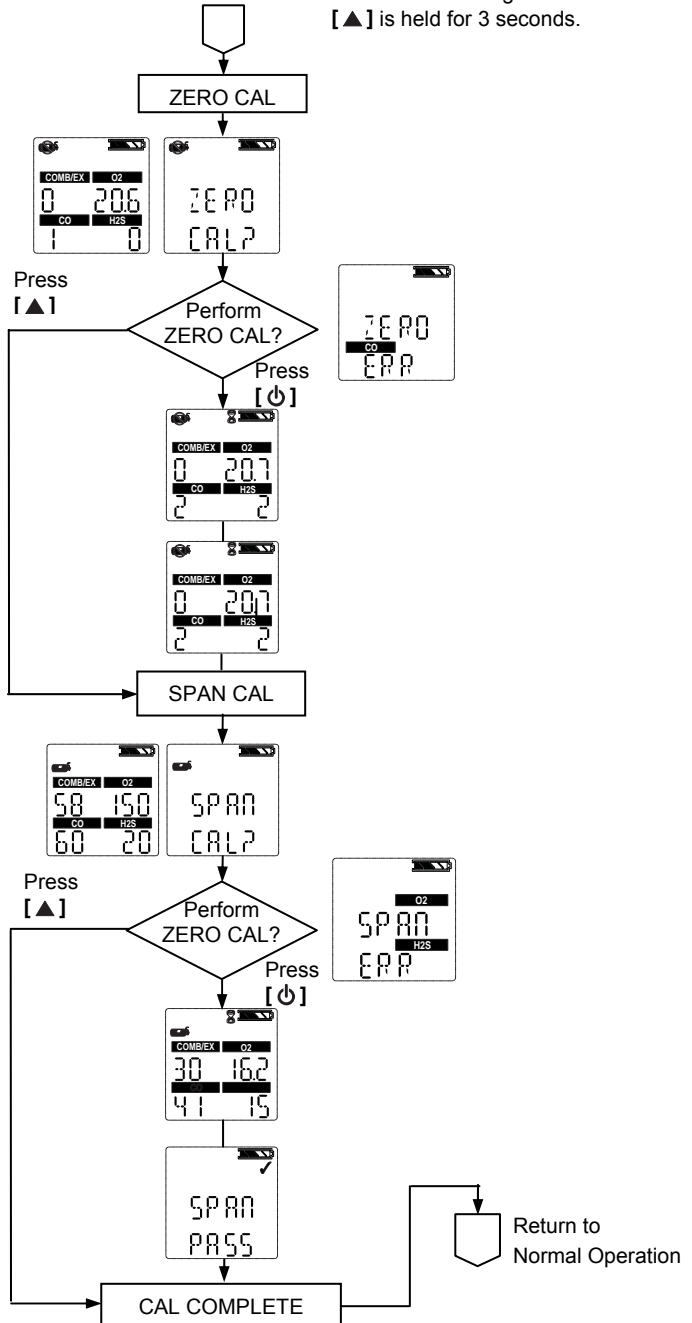

7.8 Alarm Setup

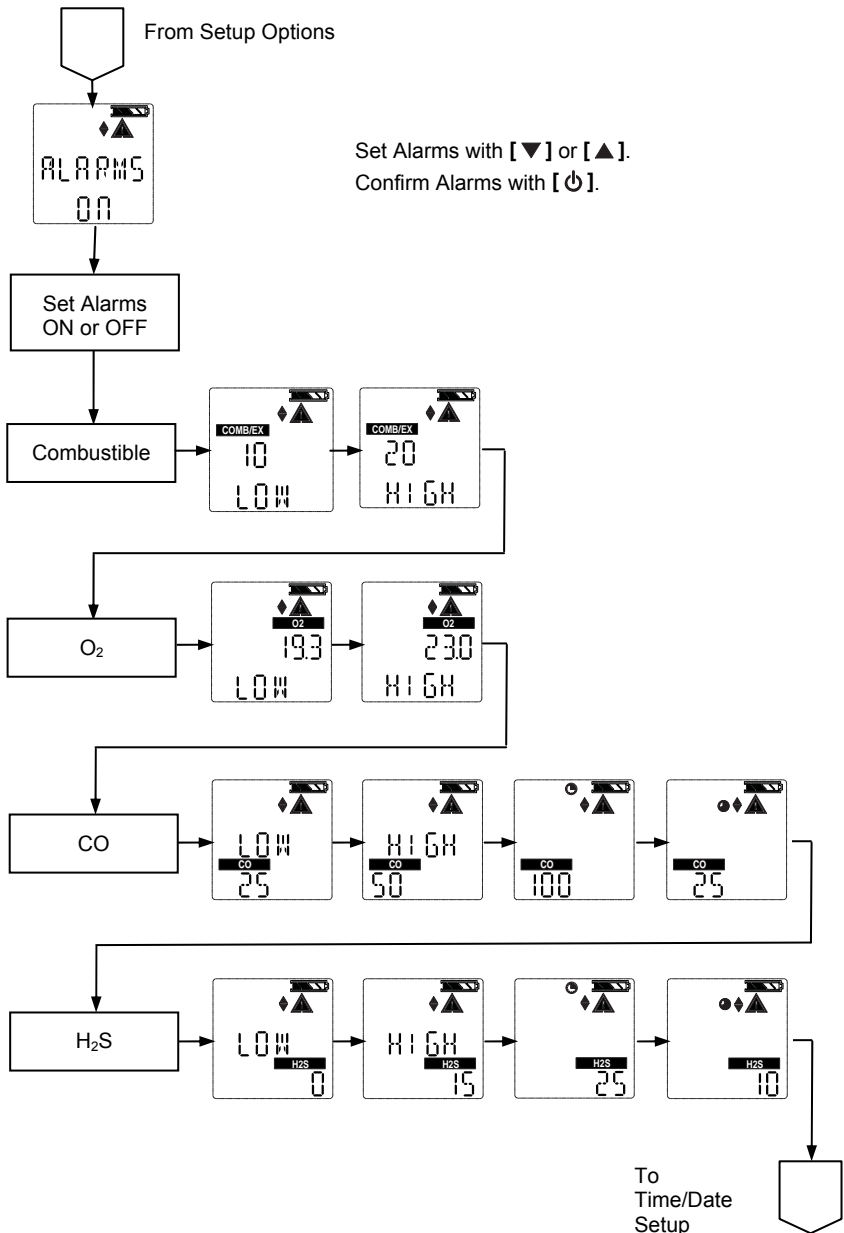

7.9 Time and Date Setup

